

ADVANCE
technology

ÓPaini

ADVANCE
technology

ÓPaini

ÓPaini

lemans

Velocità di pensiero - Speed of Thought



lemans



90CR21

Miscelatore monoforo lavabo, scarico automatico
Single-lever basin mixer with pop-up waste



OPaini



La cartuccia **ENERGY SAVING** è intercambiabile con la cartuccia standard da 35 mm.

ENERGY SAVING è una tecnologia che permette di fornire solo acqua fredda con la leva posizionata nel mezzo:

- risparmiando energia;
- risparmiando acqua calda;
- risparmiando economicamente;
- rispettando l'ambiente.

lemans

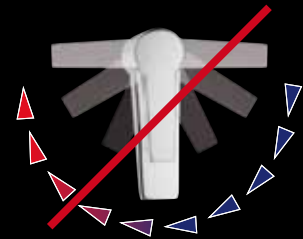

SISTEMA TRADIZIONALE
TRADITIONAL SYSTEM

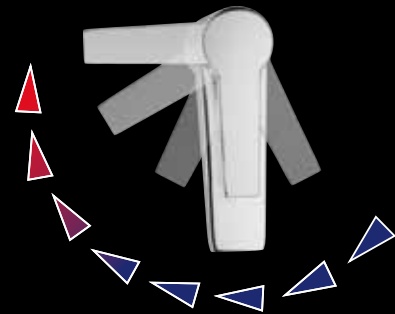

SISTEMA ENERGY SAVING
ENERGY SAVING SYSTEM

ENERGY SAVING cartridge is interchangeable
with the standard 35 mm seat.

ENERGY SAVING is a technology that allows to supply
only cold water with the lever in middle position:

- saving energy;
- saving hot water;
- sparing money;
- respecting the environment.

OPaini

DaxR Small

DaxR Small



84CR2IIRS

Miscelatore monoforo lavabo, scarico automatico
Single-lever basin mixer with pop-up waste



84CR306RS

Miscelatore monoforo bidet, scarico automatico
Single-lever bidet mixer with pop-up waste

OPaini

WBth
waterbox

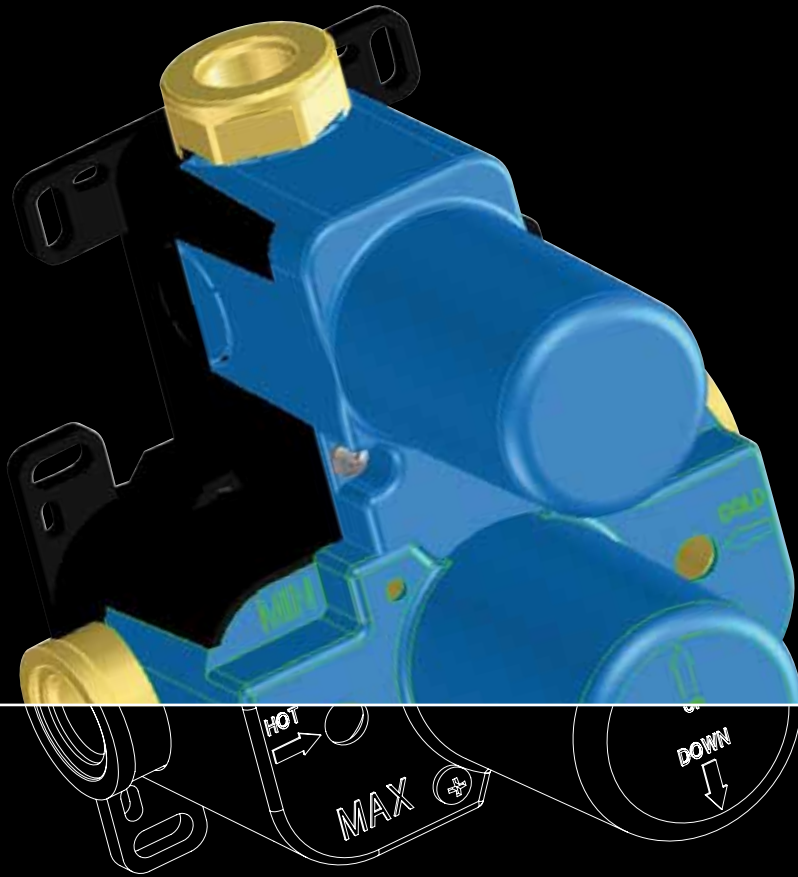

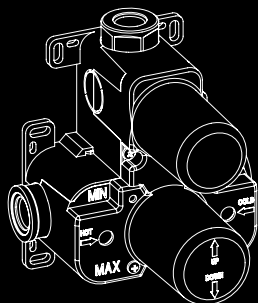

WATER BOX 690TH / 691TH - Miscelatore Universale Termostatico

Water Box il nostro nuovissimo sistema modulare da incasso.

Risolve il problema della scelta immediata della rubinetteria che si vuole acquistare. Infatti Water Box è un unico gruppo doccia adattabile a svariate serie di articoli per arredare l'ambiente bagno con assoluta tranquillità.

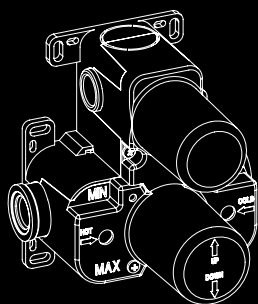

WATER BOX 690TH / 691TH - Universal Thermostatic Mixer

Water Box is our fully new built-in modular system.

A solution to avoid the immediate choice of your tap fittings.

Water Box is the only built-in shower system adaptable to several tap series to furnish your bathroom in total calm.

OPaini

WBth waterbox

690TH WATER BOX

LATO USCITA DOCCIA - scarico libero a 38°
SHOWER OUTLET - 38° waste

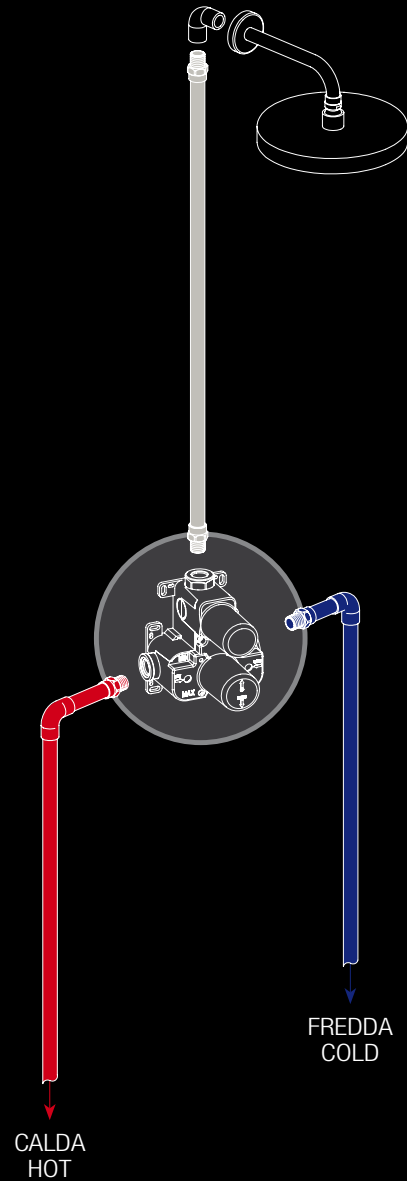
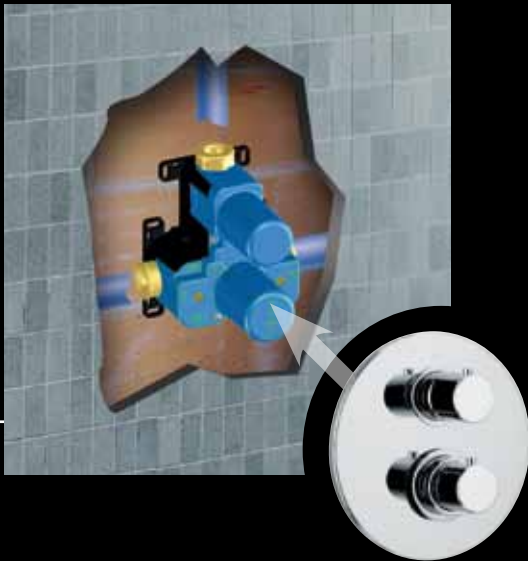
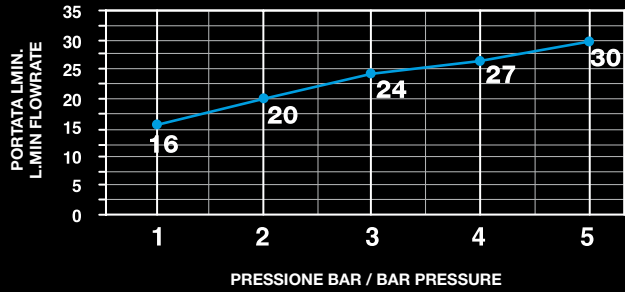

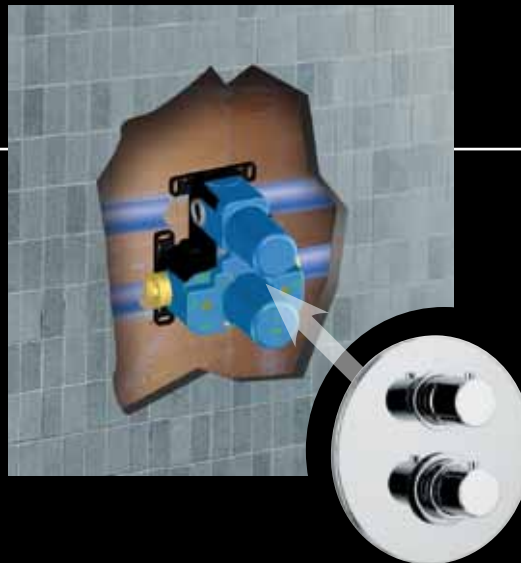
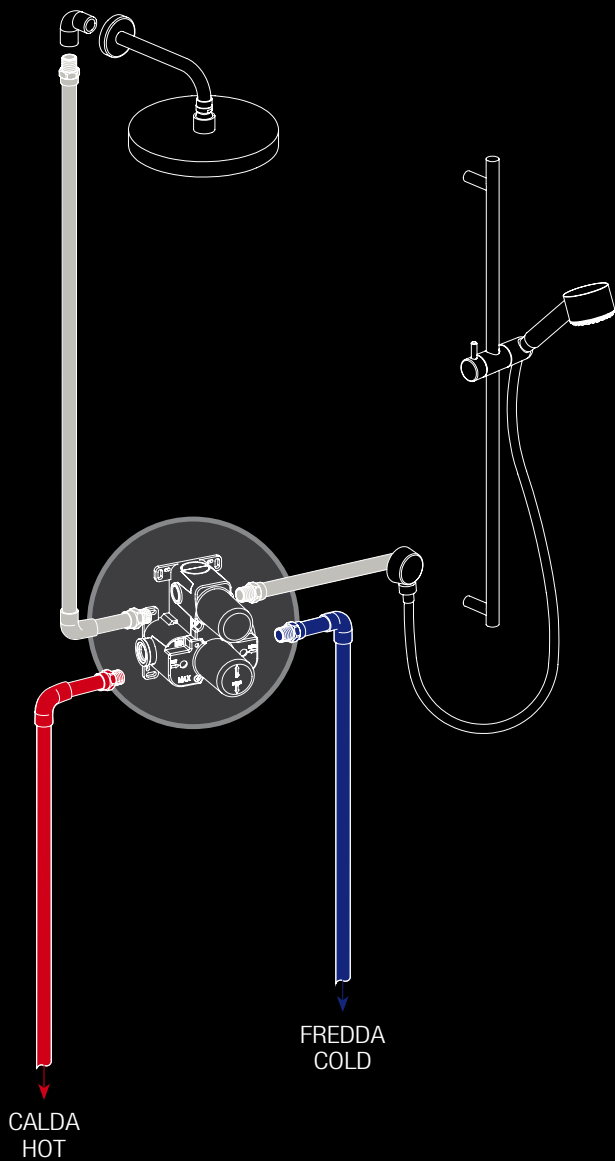

LATO USCITA DOCCIA (*) - Scarico libero a 38°
 SHOWER OUTLET(*) - 38° waste

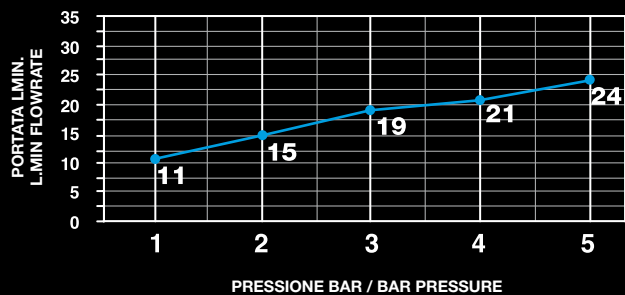

(*) in questo caso le uscite sono due, comandate da cartuccia deviatrice.
 (*) two outlets in this case, controlled by a diverting cartridge.

691TH WATER BOX

Paini



LADY
89.690TH



OVO
86.690TH

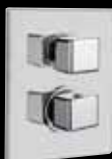

DAX-R
84.690TH



COX
78.690TH



ARENA
92.690TH

690 | **WB**th

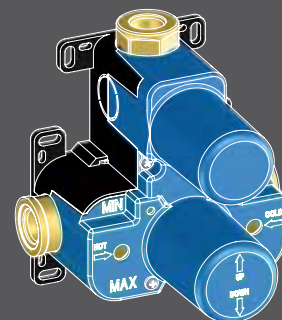

691 | **WB**th

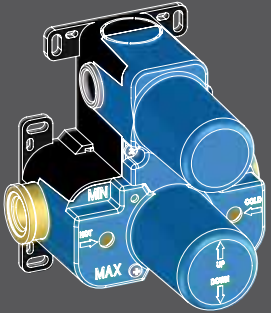

LADY
89.691TH



OVO
86.691TH



DAX-R
84.691TH



COX
78.691TH



ARENA
92.691TH





LADY
89.690



OVO
86.690



DAX-R
84.690



COX
78.690



LE MANS
90.690



ARENA
92.690

690 | **WB**

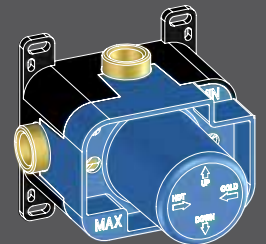

691 | WB

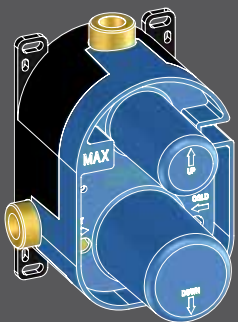

LADY
89.691



OVO
86.691



DAX-R
84.691



COX
78.691



LE MANS
90.691



ARENA
92.691



OPaini

ÓPaini

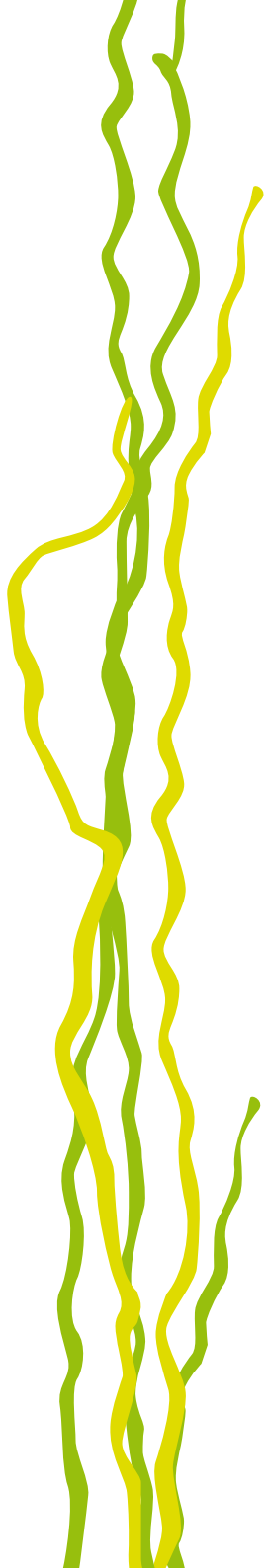

100%
green

ecological
solution

ecological solution



45CR211TC - MIXO TC

Miscelatore monoforo lavabo, scarico automatico
Single-lever basin mixer with pop-up waste

ENERGY[®]
saving 



Cromo³

watersaving

Progettiamo da sempre prodotti che rispondono alle esigenze della nostra clientela, non sottovalutando la parola ambiente.

Tutte le nostre linee produttive rispettano i più alti standard internazionali per la qualità e l'ecologia.

100%
green



design Arch. **Mirko Bosio**

SRCR211 - SPIDER

Miscelatore monoforo lavabo, scarico automatico
Single-lever basin mixer with pop-up waste



90CR211 - LE MANS

Miscelatore monoforo lavabo, scarico automatico
Single-lever basin mixer with pop-up waste

*Since ever our projects meet our customers' demand,
never underestimating the environment.*

*All our series meet the highest international standards
of quality and ecology.*

OPaini



Cromo³

100% RICICLABILE

L'atteggiamento di responsabilità che la nostra azienda ha sempre adottato nel rispettare ogni norma produttiva ed ambientale, ha stimolato la ricerca e permesso così di proporre prodotti a minor impatto ambientale, essendo questi **100% riciclabili**.

Ciò è stato possibile utilizzando l'**alluminio**, riconosciuto come metallo duttile e molto leggero. Questo, abbinato a **componenti plastici** e ad una **tecnologia** che garantisce il minor consumo di acqua, ha permesso di ottenere il massimo risultato tra i prodotti eco-sostenibili. Un buon contributo a mantenere il "nostro ambiente" migliore.

100% RECYCLABLE

*Our attitude of responsibility towards any production and environmental standard has developed our research and sorted products with low environmental impact, **100% recyclable**.*

*This has been possible by using **aluminium**, well known as ductile and light. Combined with **plastic components** and water saving **technology**, this metal has allowed to reach the best result among ecological products. A good contribution to improve "our environment".*

CROMATURA TRIVALENTE

Con un impatto minimo sull'ambiente rispetto la cromatura tradizionale, **CROMO³** ci permette di ottenere superfici brillanti e allo stesso tempo resistenti agli urti.

CROMO³ sa coniugare estetica ed ecologia in una sola finitura, per garantire prodotti di qualità nel rispetto dell'ambiente che ci circonda.

TRIVALENT CHROME

*With a minimum impact on the environment in comparison with traditional chrome, **CROMO³** create brilliant and at the same time impact enduring surfaces.*

***CROMO³** combines aesthetics and ecology in one finish to guarantee quality products that also respect the environment.*

Garantiamo un futuro migliore!

We guarantee a better future!

OPAINI



watersaving

MENO SPRECO PIÙ ENERGIA

Tutte le nostre nuove collezioni sfruttano le tecnologie più avanzate, tra cui **energy saving** e **water saving**, ponendo grande attenzione alle ecologia per salvaguardare l'ambiente e il futuro delle prossime generazioni.

LESS WASTE MORE ENERGY

*All our new collections exploit the most innovative technologies, among which **energy saving** and **water saving**, with great attention to ecology to safeguard the environment and the future of the new generations.*

100%
green





La cartuccia **ENERGY SAVING** è intercambiabile con la cartuccia standard da 35 mm.

ENERGY SAVING è una tecnologia

che permette di fornire solo acqua fredda con la leva posizionata nel mezzo:

- risparmiando energia;
- risparmiando acqua calda;
- risparmiando economicamente;
- rispettando l'ambiente.

ENERGY SAVING cartridge is interchangeable in the standard 35 mm seat.

ENERGY SAVING is a technology that allows to supply only cold water with the lever in middle position:

- saving energy;
- saving hot water;
- sparing money;
- respecting the environment.

water saving



Riduzione del consumo di acqua.

Con la nuova cartuccia dotata di limitatore, puoi risparmiare il 50% di acqua, mantenendo un flusso sufficiente per ogni condizione d'uso, senza perdite d'acqua e di energia.

Water consumption reduction.

The new cartridge equipped with limiting device enables up to 50% of water saving though maintaining a full and steady flow in every possible condition of use.

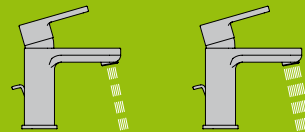

water technology

Le più moderne tecnologie unite alla cura del dettaglio, per offrire un prodotto di design e qualità sotto il profilo tecnico ed estetico.

The most innovative technologies combined with extreme care for details to offer design and first class quality both from a technical and aesthetical standpoint.



watersafety



Il sistema di controllo del grado di calore dell'acqua avviene attraverso il **limitatore di temperatura.**

Il sistema agisce direttamente sulla cartuccia, permette così di evitare un eccessivo consumo di acqua calda e protegge da un eventuale pericolo di scottatura.

*The check system of water heat is guaranteed by the **temperature limiting device.***

This acts on the cartridge directly and avoids excessive hot water consumption preventing any burns.

waterclean

Funzione anticalcare.

La pulizia è facilitata da sistemi anticalcare per un prodotto efficiente negli anni.

Anti-limestone function.

Cleaning has never been so easy thanks to the anti-limestone systems which guarantee the efficiency of a longlasting product.

100%
green

OPaini



Il tuo impianto preinstallato / *Your pre-installed system*

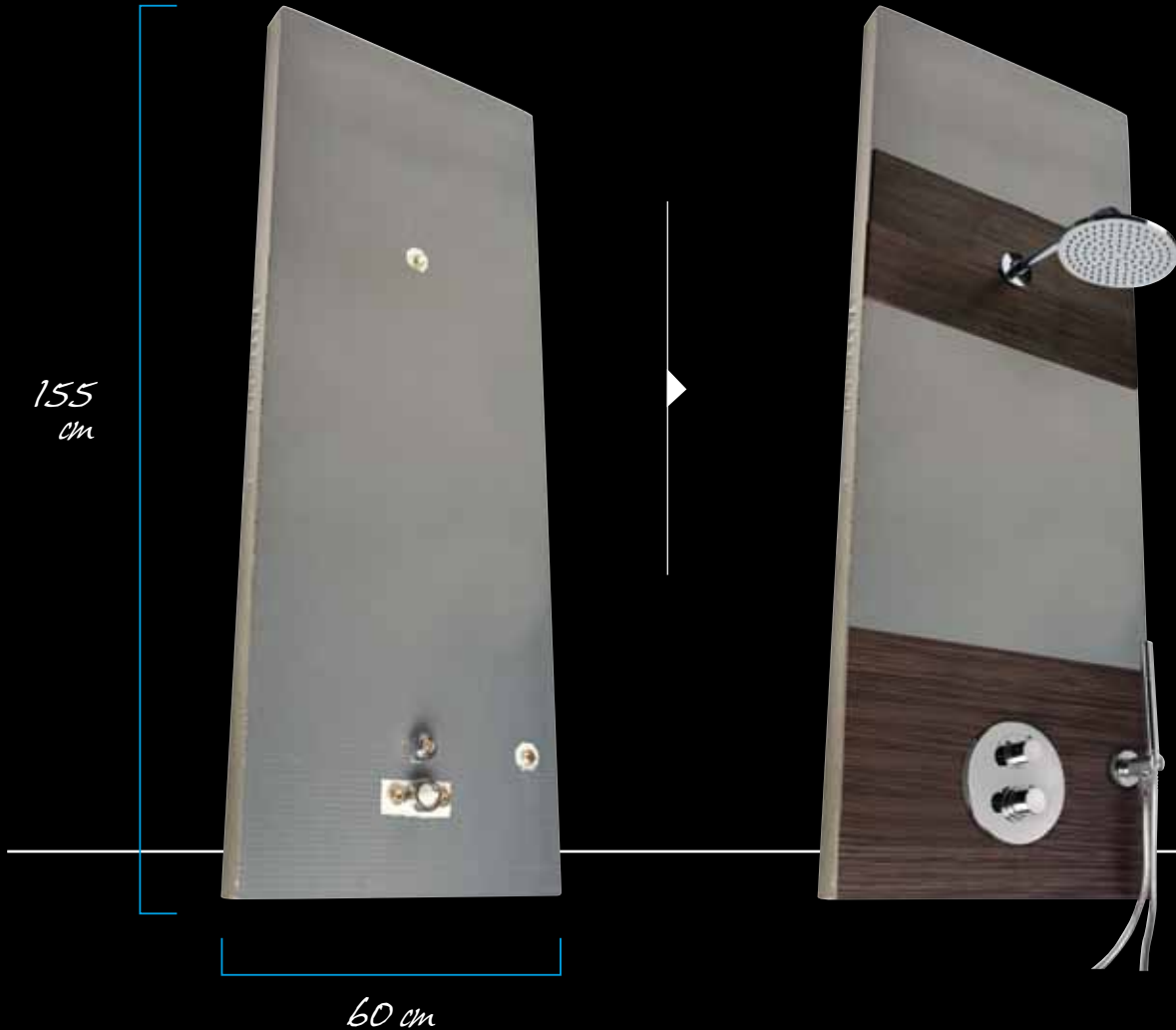

showerwall

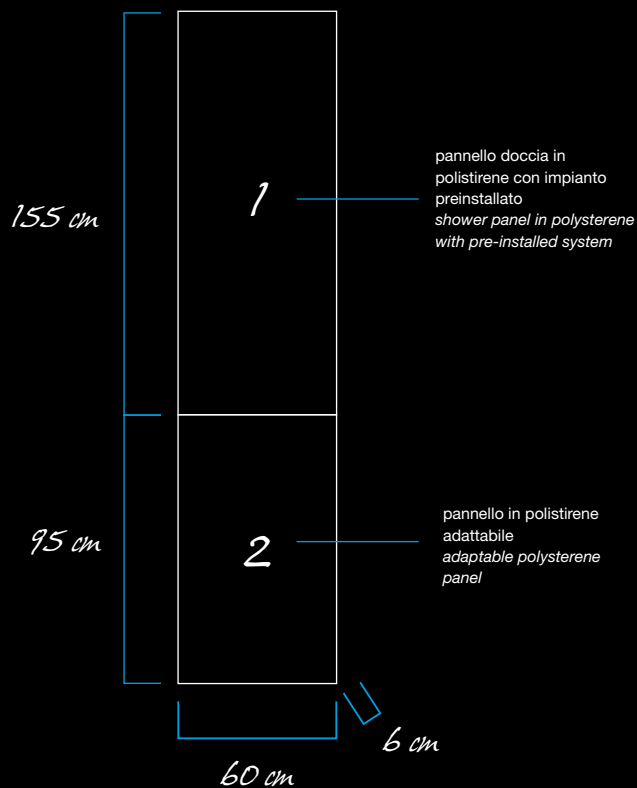

Shower Wall pannello doccia in polistirene con impianto preinstallato (escluse parti esterne di rubinetteria) è la soluzione innovativa, semplice e veloce per creare la tua doccia.

- Estrema rapidità e facilità di installazione;
- adattabile a tutte le esigenze di altezza, grazie al pannello inferiore (fig. 2) che può essere adattato a seconda delle esigenze in fase di installazione;
- facile da trasportare per le dimensioni ridotte dei due pannelli: 60x155x6 cm (fig. 1) - 60x95x6 cm (fig. 2);
- personalizzabile nel rivestimento superficiale e nella rubinetteria;
- adatto ad ogni tipo di rivestimento;
- leggero e maneggevole.

Shower Wall shower panel in polystyrene with pre-installed system (external tap fittings excluded) is the innovative, easy and quick solution to create your shower box.

- Extremely quick and easy installation;
- adaptable to any height thanks to the lower panel (fig.2) which can be adjusted during the installation;
- easy to transport with the small size of the two panels: 60x155x6cm (fig.1) - 60x95x6cm (fig.2);
- customizable in the cover and tap fittings;
- adaptable to any cover;
- light and easy to handle.

ADVANCE
technology

Paini

Paini S.p.a. Rubinetterie

Via Cremosina, 43 - C.P. 8241198 - 28076 POGNO - Italy - tel. +39 0322 9971 - fax +39 0322 997302

www.paini.com - paini@paini.com

ÓPaini

www.paini.com